

ACCESSORIES

Car Adapter

Enables you to re-charge your battery with your vehicle's electrical system.



Part No. 900507

Battery Cell

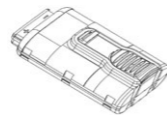

Part No. 018880

Battery Charger

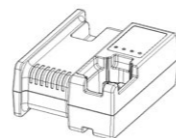

Part No. 018881 (EU)
018882 (UK)

Cable

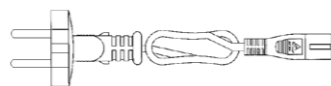

Part No. 018885 (EU)
018886 (UK)

9/65" Hex Key

For cleaning tool

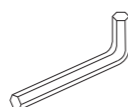

Part No. 900736

Orange Safety Glasses



Part No. 011117

Paslode Intensive Tool Cleaner 300 ml

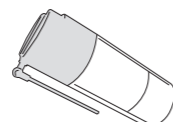

Part No. 115251

Paslode Impulse Lubricating Oil

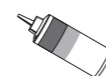

Part No. 401482

Carrying Case



Part No. 014975

Cleaning Kit

Contains all the necessary to clean any Impulse tool

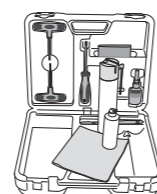

Part No. 013060

Paslode®

Impulse®

Part No. 013312 (EU)
Part No. 013313 (UK)



IM65A F16 Lithium

IMPORTANT! DO NOT DESTROY

Always refer to operating and safety instructions (#018909 & #014744) for detailed information on this tool. It is the customer's responsibility to have all operators and service personnel read and understand this information.

TOOL SCHEMATIC AND PARTS



An Illinois Tool Works Company
Route de Lyon - BP 104
F - 26501 Bourg Les Valence - Cedex France

018906-1
04/13

LEGEND IM65A F16 Lithium

Part No. 013312 (EU), 013313 (UK)

1	013715	1	Grille	50	903501	1	Handle/Right
* 2	900648	1	Filter	53	018922	1	Fuel Door
3	901064	4	Shoulder Screw 8-32 x 1-3/8"	54	902235	1	Retaining Ring-Pin-Fuel Door
4	018920	1	Cap	55	902434	1	Nut-Utility Hook
5	904557	2	Screw, SHC	56	902433	1	Button
6	901119	1	Retaining Ring	57	902431	1	Block-Utility Hook
7	901382	1	Fan Motor Assembly with Ring	58	902432	1	Spring
*8	401356	1	Motor Sleeve	59	902435	1	Stop Utility Hook
9	900785	1	Insulator	60	902430	1	Utility Hook
10	900714	1	Spark Plug Assembly	61	901044	1	Soft Grip
11	018921	1	Cylinder Head	62	902440	1	Spark Unit (MSU)
15	900697	1	Stem adapter	63	900662	1	ESU Power Wire Assembly
16	900596	1	SEMS Screw, Torx	64	904562	1	Fan Motor Wire Assembly
17	900739	1	Cylinder Head Circuit Board Assy.	65	018927	1	Nameplate
18	900612	4	Seal Ring	66	902621	1	Battery Pad
19	900709	1	Fan Assembly	67	902439	1	Molded Circuit Assembly
20	900700	1	Air Dam	68	900726	1	Switch Slide Assembly
21	900729	1	Combustion Chamber	69	900792	2	Soc. Hd. Shoulder Screw 8-32
22	900707	2	Probe Bumper	70	404702	2	Screw 6-32 x 3/8"
23	900746	2	Screw, #8-32 x 7/16	71	904567	1	Spark Wire Assembly
24	900704	1	Yoke	72	901053	1	Trigger Spring
25	900734	1	Roll Pin	73	901082	1	Trigger Assembly
26	900804	2	Spring Guide Assembly	74	901047	1	Dowel Pin, Trigger
27	902437	1	Knob w/ Yoke Guide Assembly	75	900629	1	Clip/ High Tension
28	902424	1	Probe	76	900770	1	Brad Channel
*29	902425	1	Probe Tip	77	902404	1	Magazine Extrusion
30	013706	1	Latch Cover, Quick Clear Black	78	902421	1	Nose
31	900619	1	Dowel Pin	79	900631	1	Spring, Lockout
32	902457	1	Front Plate Assembly	80	900602	1	Lockout Bar
33	900685	1	Dowel Pin	81	900630	1	Lockout Pin
34	902426	1	Quick Clear Lever Assembly	82	900660	2	Screw 10-32 x 3/8"
35	405140	4	Screw 8-32 x 3/8" (red)	83	900692	1	Retaining Cup
36	900668	1	Muffler Cover	84	900708	2	SHC Screw 8-32 x 1/2" (Red)
37	900609	1	Muffler	85	900754	1	SHC Screw 8-32 x 1/2" (Yellow)
38	900664	1	Reed Valve	86	900722	1	Follower Pin
39	900665	1	Reed Plate	87	900679	1	Follower
40	901089	1	Exhaust Baffle	88	900691	1	Compression Spring
41	900616	1	Exhaust O-Ring	89	900627	1	Negator Spring
42	403099	1	Retaining Ring	90	900720	1	Follower Core
43	403098	1	Piston Ring	91	900617	1	Follower Body
*44	900728	1	Piston Assembly	92	900724	1	Screw, Plastite 8-16 x 5/8"
*45	900680	1	Piston Bumper	93	901066	4	Screw, Plastite 8-16 x 3/4"
46	018924	1	Label, Li-Ion IM65A F16	94	902417	1	Nail Load Indicator Label
48	902416	1	Depth of Drive Indicator Label	95	018923	1	Handles labels assembly
49	900620	1	Front Channel	97	903502	1	Handle, Left
				98	902456	1	Cylinder Sleeve Assembly

* Indicates normal wear items

→ Denotes Change

■ Apply Loctite RC-620 (Green)

SAFETY INSTRUCTIONS

WEAR EYE AND HEARING PROTECTION



Always wear eye and hearing protection when operating a nail tool.



IM65A F16 Lithium

Part No. 013312 (EU), 013313 (UK)

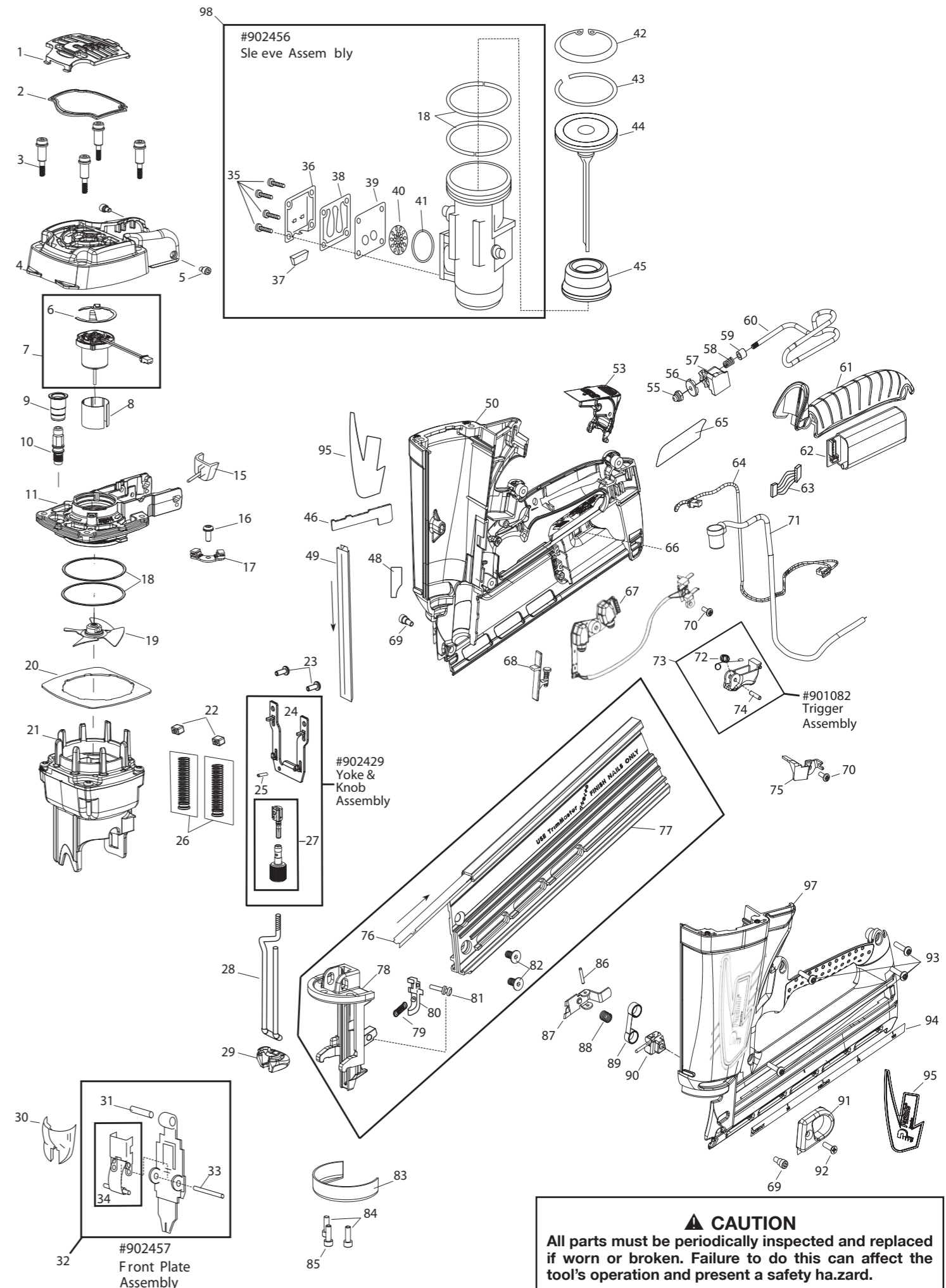

CAUTION
All parts must be periodically inspected and replaced if worn or broken. Failure to do this can affect the tool's operation and present a safety hazard.